

OACIS

Open Architecture Control Integrated System

Encoder Wiring Example with Keyence

Version 01.04



www.atainc.com

ata@atainc.com



All Rights Reserved

CONTENTS

- I. MODEL SELECTION 3
- II. EXMAPLE #1 4

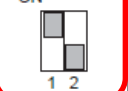

I. MODEL SELECTION

- A. It is normally composed of “Sensor Amplifier”, “Sensor Head” and “Connection Cables”.
- B. When selecting a **Sensor Amplifier**, you should choose “Pulse Output” type(GT2-71D).
- C. Pulse Output Setting of GT2-71D
- i. **Minimum phase difference:** Set as **2.5 us**.

0.5 μ s	2.5 μ s*	5 μ s	25 μ s
ON 	ON 	ON 	ON 

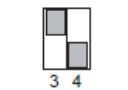

* This is the factory default setting.

- ii. **Pulse resolution:** Set as the same resolution of the sensor head that you use.
 - a. For example, when using GT2-H12K, you should set the pulse resolution as 0.1 μ m
 - b. When using a sensor head other than GT2-H12K(L), even if the pulse resolution is set to 0.1 μ m, a resolution of 0.5 μ m is used.

0.1 μ m	0.5 μ m*	1 μ m	10 μ m
ON 	ON 	ON 	ON 

* This is the factory default setting.

- iii. **Pulse fluctuation direction:** Set as 5(OFF)

Pulse expands when the spindle is pushed in*	Pulse shrinks when the spindle is pushed in
ON 	ON 

* This is the factory default setting.

- A. 보통 “센서증폭기”, “센서헤드”, “연결케이블”로 구성되어 있습니다.
- B. 증폭기를 선택할 경우, “펄스출력” 타입(GT2-27D)으로 골라야 합니다.
- C. 펄스출력셋팅(GT2-71D)
- i. 최소위상차: 2.5 μ m로 셋팅하십시오.
 - ii. 펄스해상도: 사용할 센터헤드와 같은 해상도로 셋팅하십시오.
 - a. 예를 들면, GT2-H12K를 사용한다면, 펄스해상도를 0.1 μ m로 셋팅하십시오
 - b. GT2-H12K(L) 이외의 센서헤드를 사용한다면, 펄스해상도를 0.1 μ m로 셋팅하더라도 0.5 μ m 해상도로 적용됩니다.
 - iii. 펄스변동방향: 5(OFF)로 셋팅하십시오.

II. EXMAPLE #1

- A. Selected Model: KEYENCE #GT2-H12K(Head) + GT2-71D(Amp).
 - i. Sensor Head: Resolution: 0.1 um
 - ii. Sensor Amp Setting
 - a. Min Pulse Difference: 2.5 us
 - b. Pulse Resolution: 0.1 um
- B. OACIS Input Signals: LINE RECEIVER
- C. Pulse Ratio in the System Configuration: 10,000 (= 1 / 0.0001)
- D. Pin Map

OACIS DK Channel		KEYENCE (GT2-71D)	
PIN #	Description	PIN #	Description
1	+Vcc (5V)	Not Connected	
OACIS 24V		BROWN	DC 10~30 V
2	0V	Not Connected	
OACIS 0V		BLUE	0V
3	A	BLACK	A
4	/A	VIOLET	/A
5	B	WHITE	B
6	/B	GRAY	/B
7	Z	ORANGE	Z
8	/Z	GREEN	/Z
9	Shield		
Not Connected		Pink	Current Position Request Input

- i. KEYENCE “DC 10~30V”(BROWN) and “0V”(BLUE) should be connected to “OACIS 24VDC output channel”. OACIS DK channel does not offer 24V, but offer just “5Vcc”.
- ii. KEYENCE “External input”(Pink) is not to be connected.
- iii. There is no Shield wire in the KEYENCE(GT2-71D) cable.
- iv. You can make inquiry at KEYENCE for a separate cable with bare wires. It would be helpful for better wire connection.

E. Wire Example

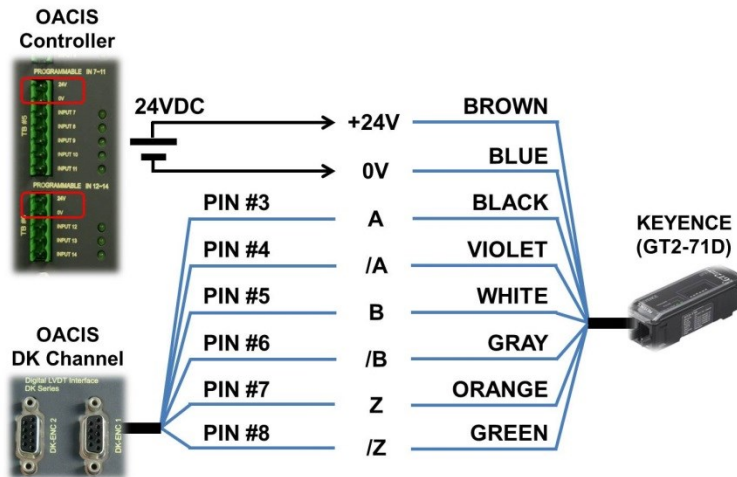

- F. Different KEYENCE connector has different Pin Number. You need to see the description carefully. Above example is for #GT2-71D.
- G. Set Encoder Inputs in System Configuration

